

<https://electricassistcart.com>

海南金海芯科技控股有限公司

Hainan Jinhaixin Technology Holdings Co., Ltd

FomaTrade@outlook.com

产品手册 Product manual

FomaTrade@hotmail.com

编制(Edit): 李工 (li)

审核(Check): 杨工 (yang)

<https://electricassistcart.com>

批准(Approval): 杨先生 (R' yang)

FomaTrade@outlook.com

2024年04月01日

May, 04, 2024

-----由深圳市金海芯控股有限公司技术支持版权所有-----

FomaTrade@hotmail.com

Technical support by Shenzhen Jinhaixin Holdings Co., Ltd. All rights reserved



Product name: DC brushless gearless motor
FomaTrade@outlook.com

Specification Model: 10 inch single shaft diameter
255MM tire width 67MM 105S
30H-5-12 (six-leaf plum model)
FomaTrade@hotmail.com

Product coded: FomaTrade-241710D05123036D1-009

Motor structure combination diagram:

<<MOTOR STRUCTURE>>

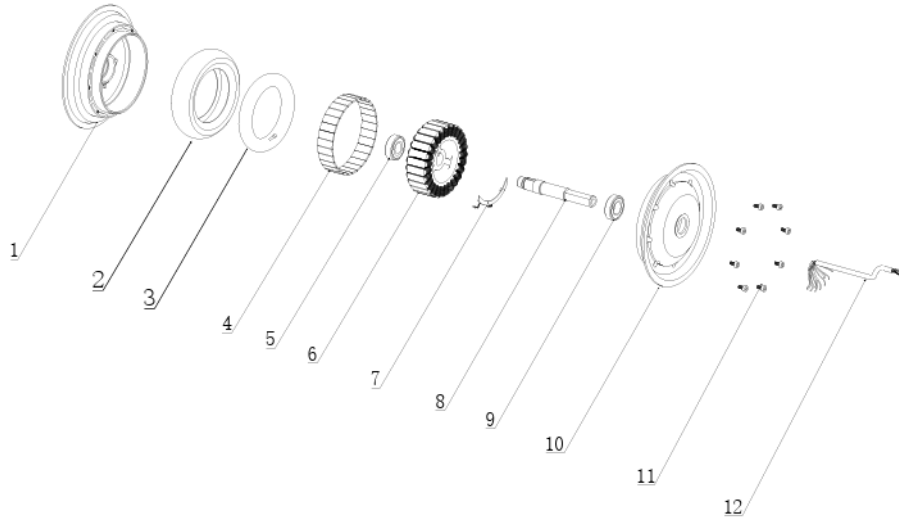

il.com

- 1: Hubcap (outer) 2: Tires (outer) 3: Tires (Inner) 4: Magnet
- 5: bearing 6: Silicon steel sheet 7: Hall sensing 8: axis
- 9: bearing 10: Wheel hub (inner) 11: screw 12: wire rod

<https://electricassistcart.com>

Motor dimensional drawing:

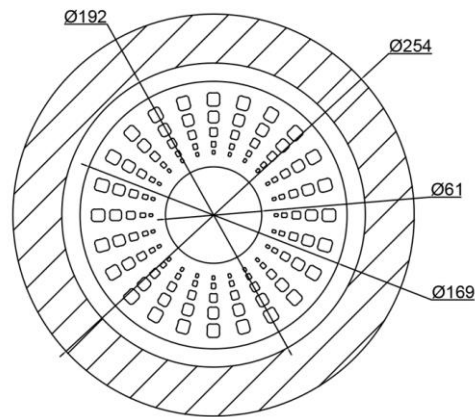
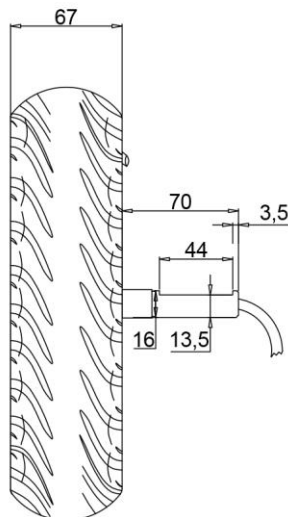

Basic performance parameters:

serial number	Projects	specification	remark
1	Motor diameter	255mm (There is a slight error in size)	The actual product shall prevail
2	Rated voltage	36V	
3	Rated power	350W	
4	Rated rotating speed	500±30rpm	
5	Rated current	8±0.5A	
6	Theoretical torque	15.9N/M	
7	Degree of phases	120°	
8	Number of poles	15Number of pole pairs	30PCS
9	Size of magnetic steel	38M;30mmx11.2mmx3mm	NdFeB
10	Size of enamelled wire	Enameled round copper wire	QZ-C180
11	Coil winding	0.51# *5*12	
12	Size of stator core	105#	3.5
13	Number of solts	27	
14	Size of lead wire	3x1.5 ² -5x0.1 ²	Teflon
15	lead exposed	300mm	
17	No-load current	≤0.3A	
19	Withstand voltage	0.5KV ≤10mA	
20	Insulation degree	≥500MΩ	
21	Shaft material	45 steel	40Cr
22	Out of the shaft	Single-sided shaft D-shaped briquetting model	
23	Waterproof rating	IP54	
24	Maximum load	120kg	
25	Environmental requirements	-20℃~65℃	

Test the data waveform: 24v

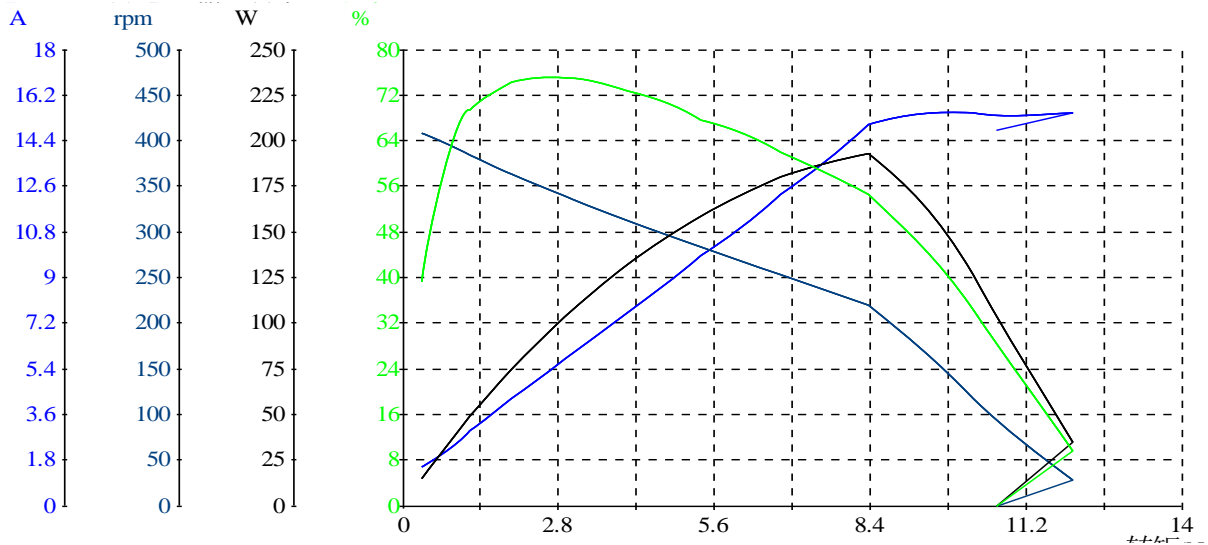

Feature points	voltage	current	Input power	Torque	rotate speed	Output power	efficiency	Time
	V	A	W	N. m	rpm	W	%	S
No_Load	24.09	1.534	36.93	0.34	408.6	4.46	39.2	0.000
Eff_max	23.98	5.187	124.2	2.57	347.6	93.53	75.3	17.10
Pout_max	23.69	15.03	354.8	8.38	220.1	193.2	54.5	43.26
Torque_max	23.66	15.49	366.4	12.05	27.8	35.08	9.6	55.33
End	23.69	14.81	350.4	10.66	0	0	0	57.35

<https://electricassistcart.com>

Dynamometer report data: 24v

serial number	voltage	current	Input power	Torque	rotate speed	Output power	efficiency	Time
	V	A	W	N. m	rpm	W	%	S
1	24.09	1.534	36.93	0.34	408.6	4.46	39.2	0.000
2	24.08	1.638	39.42	0.44	406.0	18.70	47.5	3.011
3	24.07	2.329	55.99	0.96	391.7	39.45	70.5	5.024
4	24.05	2.934	70.38	1.21	383.9	48.80	69.3	7.036
5	24.03	3.319	79.53	1.44	377.6	57.01	71.7	9.049
6	24.02	3.762	90.20	1.69	370.1	65.56	72.7	11.06
7	24.01	4.207	100.7	1.97	363.0	74.72	74.2	13.07
8	24.00	4.680	112.1	2.26	355.5	84.27	75.1	15.09
9	23.98	5.187	124.2	2.57	347.6	93.53	75.3	17.10
10	23.96	5.772	137.9	2.92	338.7	103.6	75.1	19.11

Dc brushless hub motor products

11	23.95	6.344	151.4	3.28	330.4	113.4	74.9	21.12
12	23.93	6.941	165.8	3.64	321.6	122.7	74.0	23.14
13	23.91	7.625	181.9	4.05	312.0	132.4	72.8	25.15
14	23.88	8.293	197.5	4.46	302.8	141.5	71.6	27.16
15	23.87	8.981	213.8	4.91	293.3	150.7	70.5	29.17
16	23.84	9.860	234.6	5.36	283.1	158.9	67.7	31.19
17	23.82	10.52	250.2	5.82	273.4	166.5	66.5	33.20
18	23.80	11.32	268.6	6.31	263.5	174.1	64.8	35.21
19	23.77	12.25	290.1	6.79	253.3	180.2	62.1	37.22
20	23.74	13.08	309.9	7.32	241.9	185.4	59.8	39.24
21	23.72	13.97	330.4	7.84	231.5	190.0	57.5	41.25
22	23.69	15.03	354.8	8.38	220.1	193.2	54.5	43.26
23	23.66	15.50	365.7	9.09	183.9	175.0	47.9	45.27
24	23.66	15.55	367.6	9.60	159.6	160.5	43.6	47.28

FomaTrade@hotmail.com

<https://electricassistcart.com>

FomaTrade@outlook.com

FomaTrade@hotmail.com

Test the data waveform: 36v

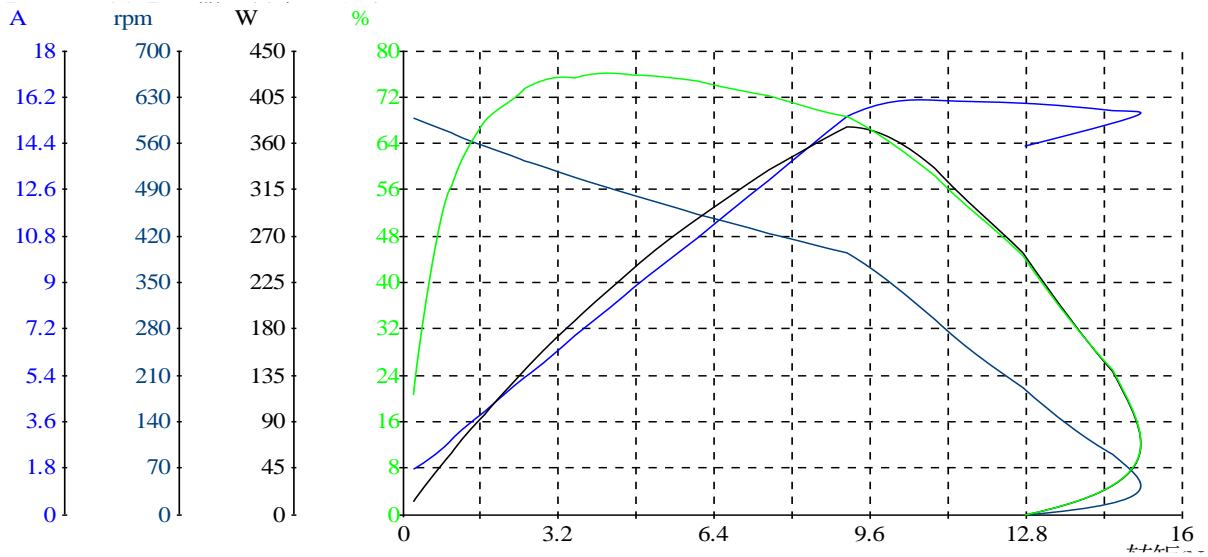

Feature points	voltage	current	Input power	Torque	rotate speed	Output power	efficiency	Time
	V	A	W	N. m	rpm	W	%	S
No_Load	36.15	1.740	62.85	0.21	598.1	12.90	20.5	0.000
Eff_max	35.95	8.086	290.1	4.30	491.4	221.2	76.3	29.17
Pout_max	35.73	15.46	550.0	9.13	393.9	376.5	68.5	49.30
Torque_max	35.72	15.76	560.3	15.93	18.7	31.18	5.6	71.43
End	35.76	14.31	511.2	12.77	0	0	0	73.45

<https://electricassistcart.com>

Dynamometer report data: 36v

serial number	voltage	current	Input power	Torque	rotate speed	Output power	efficiency	Time
	V	A	W	N. m	rpm	W	%	S
1	36.15	1.740	62.85	0.21	598.1	12.90	20.5	0.000
2	36.15	1.812	65.45	0.28	596.7	17.74	27.1	3.011
3	36.14	2.369	85.52	0.77	582.5	46.96	54.9	5.023
4	36.11	2.901	104.7	0.99	575.4	59.40	56.7	7.036
5	36.10	3.230	116.5	1.19	569.3	71.17	61.1	9.048
6	36.09	3.617	130.5	1.43	562.6	84.12	64.5	11.06
7	36.08	3.999	143.9	1.68	556.2	97.72	67.9	13.07
8	36.07	4.394	158.4	1.93	548.9	111.1	70.2	15.09
9	36.07	4.921	177.3	2.22	541.3	125.9	71.0	17.10
10	36.07	5.320	191.5	2.52	533.7	140.8	73.5	19.11

Dc brushless hub motor products

11	36.06	5.803	208.7	2.85	525.8	156.8	75.1	21.12
12	36.04	6.306	226.7	3.17	517.7	171.6	75.7	23.14
13	35.99	6.945	249.4	3.53	508.7	187.8	75.3	25.15
14	35.97	7.503	269.0	3.92	500.1	205.0	76.2	27.16
15	35.95	8.086	290.1	4.30	491.4	221.2	76.3	29.17
16	35.93	8.744	313.6	4.71	481.8	237.8	75.8	31.19
17	35.91	9.380	335.8	5.15	472.7	254.9	75.9	33.20
18	35.89	10.03	359.1	5.57	463.5	270.5	75.3	35.21
19	35.87	10.72	384.0	6.04	453.9	287.1	74.8	37.22
20	35.85	11.49	410.8	6.52	443.8	302.9	73.7	39.23
21	35.83	12.22	436.6	7.00	434.3	318.4	72.9	41.25
22	35.80	12.99	463.9	7.53	424.6	334.9	72.2	43.26
23	35.78	13.83	493.4	8.06	414.0	349.3	70.8	45.27
24	35.76	14.64	521.8	8.58	404.0	362.9	69.5	47.28
25	35.73	15.46	550.0	9.13	393.9	376.5	68.5	49.30
26	35.71	16.08	570.8	9.81	365.7	375.7	65.8	51.31
27	35.70	16.13	575.4	10.39	328.1	357.1	62.0	53.32
28	35.70	16.10	574.4	10.95	293.1	336.2	58.5	55.33
29	35.71	16.04	572.6	11.59	249.1	302.3	52.8	57.35
30	35.71	16.00	571.0	12.13	223.0	283.1	49.6	59.36
31	35.71	15.93	568.7	12.73	190.2	253.5	44.6	61.37
32	35.71	15.89	567.4	13.40	148.6	208.5	36.8	63.38
33	35.72	15.76	563.0	14.03	113.7	167.1	29.7	65.40
34	35.72	15.68	560.3	14.58	91.0	138.9	24.8	67.41
35	35.72	15.60	557.2	15.29	46.3	74.10	13.3	69.42
36	35.72	15.76	560.3	15.93	18.7	31.18	5.6	71.43
37	35.76	14.31	511.2	12.77	0	0	0	73.45

FomaTrade@hotmail.com

Test the data waveform: 48

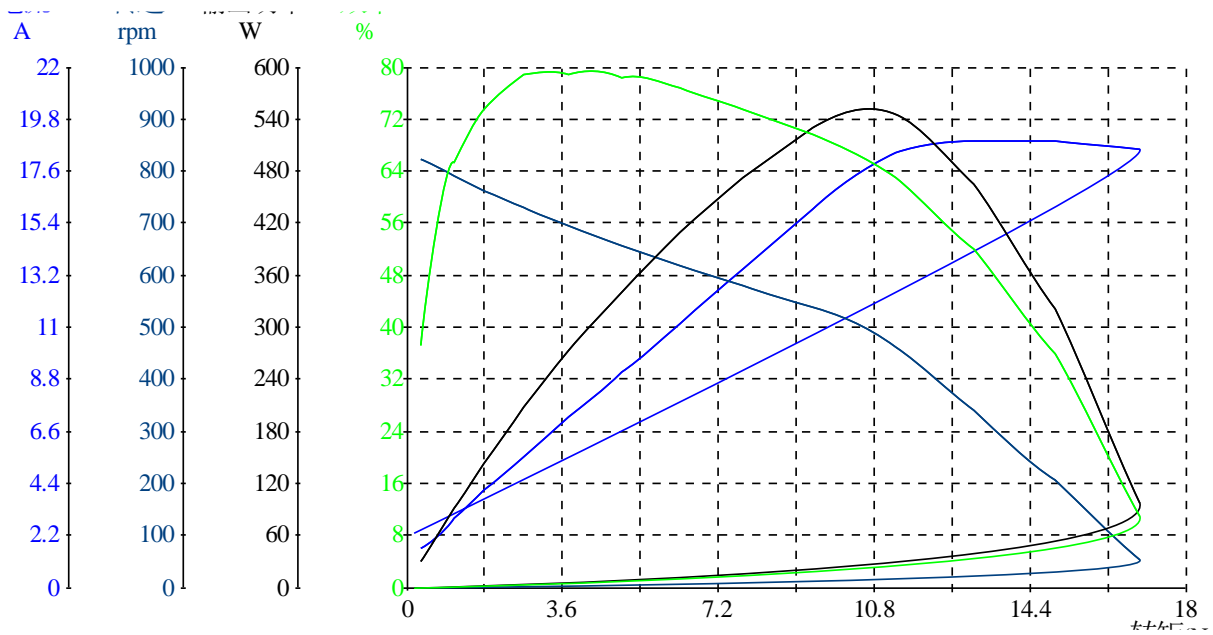

FomaTrade@hotmail.com

Feature points	voltage	current	Input power	Torque	rotate speed	Output power	efficiency	Time
	V	A	W	N. m	rpm	W	%	S
No_Load	48.12	1.644	78.93	0.34	823.6	29.32	37.1	0.000
Eff_max	47.94	7.742	370.4	4.14	681.5	295.4	79.7	27.16
Pout_max	47.61	17.77	845.1	10.56	507.1	560.9	66.4	53.32
Torque_max	47.59	17.47	829.1	17.25	9.7	17.52	2.1	75.46
End	48.08	2.251	107.7	0.17	0	0	0	77.47

Dynamometer report data: 48v

serial number	voltage	current	Input power	Torque	rotate speed	Output power	efficiency	Time
	V	A	W	N. m	rpm	W	%	S
1	48.12	1.644	78.93	0.34	823.6	29.32	37.1	0.000
2	48.12	1.749	83.94	0.44	819.8	38.11	45.4	3.011
3	48.10	2.354	113.1	0.90	799.7	75.52	66.8	5.023
4	48.08	2.907	139.6	1.10	789.9	91.30	65.4	7.036
5	48.07	3.252	156.2	1.31	781.6	106.9	68.4	9.048
6	48.06	3.663	175.8	1.56	772.0	126.3	71.8	11.06
7	48.05	4.084	195.9	1.80	761.6	143.7	73.4	13.07

Dc brushless hub motor products

8	48.04	4.516	216.7	2.09	751.5	164.3	75.8	15.09
9	48.02	5.013	240.2	2.39	740.3	185.4	77.2	17.10
10	48.01	5.503	263.4	2.72	729.5	207.4	78.8	19.11
11	47.99	6.007	287.7	3.02	718.4	227.2	79.0	21.12
12	47.97	6.556	314.0	3.37	706.2	249.5	79.5	23.14
13	47.95	7.231	346.3	3.76	693.6	272.8	78.8	25.15
14	47.94	7.742	370.4	4.14	681.5	295.4	79.7	27.16
15	47.92	8.357	399.6	4.53	669.6	317.7	79.5	29.17
16	47.87	9.107	435.3	4.96	656.5	340.9	78.3	31.19
17	47.86	9.677	461.6	5.42	644.0	365.3	79.1	33.20
18	47.83	10.44	497.8	5.84	631.1	386.1	77.6	35.21
19	47.81	11.14	531.7	6.31	618.9	408.6	76.9	37.22
20	47.79	11.93	568.4	6.78	605.3	429.9	75.6	39.23
21	47.77	12.68	604.0	7.28	592.3	451.7	74.8	41.25
22	47.74	13.45	641.0	7.78	579.4	472.0	73.6	43.26
23	47.72	14.31	680.9	8.31	565.4	491.8	72.2	45.27
24	47.69	15.14	720.3	8.85	552.1	511.3	71.0	47.28
25	47.67	16.00	761.3	9.39	538.4	529.5	69.6	49.30
26	47.64	16.88	802.3	9.94	525.0	546.3	68.1	51.31
27	47.61	17.77	845.1	10.56	507.1	560.9	66.4	53.32
28	47.59	18.39	868.1	11.31	461.3	546.1	62.9	55.33
29	47.57	18.73	890.0	11.88	429.7	534.4	60.0	57.35
30	47.57	18.88	897.5	12.54	374.2	491.1	54.7	59.36
31	47.57	18.88	897.5	13.10	339.3	465.4	51.9	61.37
32	47.57	18.89	898.1	13.70	297.1	426.0	47.4	63.38
33	47.57	18.88	897.6	14.39	239.3	360.4	40.2	65.40
34	47.57	18.85	896.4	14.97	205.1	321.5	35.9	67.41
35	47.58	18.74	891.2	15.59	158.1	258.1	29.0	69.42
36	47.58	18.67	888.0	16.31	96.7	165.1	18.6	71.43
37	47.59	18.55	882.9	16.93	54.2	96.08	10.9	73.45
38	47.59	17.47	829.1	17.25	9.7	17.52	2.1	75.46
39	48.08	2.251	107.7	0.17	0	0	0	77.47

Electrical wiring definition:

- 1、 the default definition of phase line; yellow(U) blue(V) green(W)、



图1: 电气原理图
The Electrical Principle Diagram

- 2、 Hall line; red(VCC) yellow(HA) blue(HB) green(HC) black(GND)

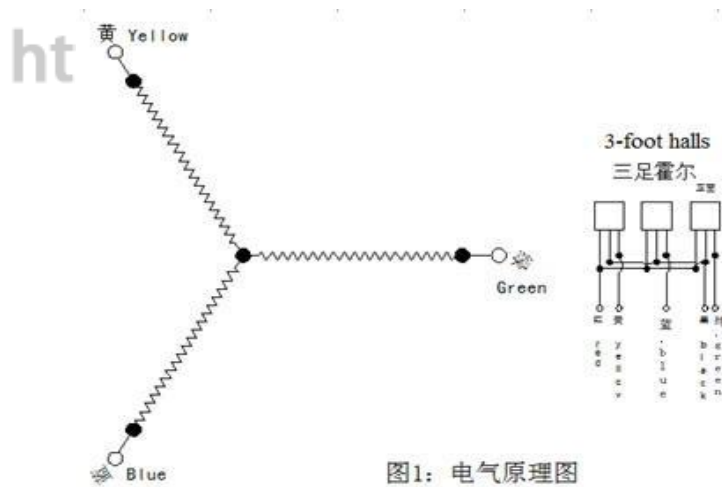
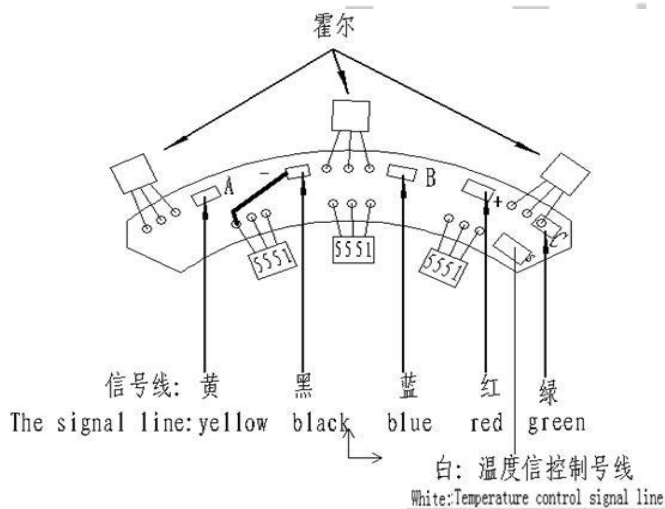

- 3、 The motor (external) rotor is a permanent magnet, integrated with the wheel hub.
- 4、 the three power cables are connected with the winding, generally using 1.0-4.0mm² high temperature line, the number line on the Hall element is 0.1-0.3mm² high temperature line.
- 5、 In the schematic diagram, "●" is the internal node, which is connected by the manufacturing plant, and "○" is the external node, which is connected by the customer.

- 6、 The power supply applicable to this product is: DC24V~DC100V power supply or lithium battery.
- 7、 when the electrical Angle of the drive output is not the same, the motor is stuck, the rotation is abnormal and there is noise, the motor is relatively hot, and the Hall line sequence or phase line sequence of the motor can be changed to achieve the electrical Angle change.
- 8、 check whether the appearance is damaged, check whether the wiring harness is broken。
- 9、 before powering on, please ensure that the drive controller and the motor are connected correctly, and ensure that the power supply voltage is within the specified range. If the operation is not as required, there may be a risk of burning out.
- 10、 For your safety, please detach the hub motor from the ground when powering on for the first time, keep the motor suspended, and then power on the drive (select according to the matching motor, start the drive motor is powered on or stuck and abnormal temperature rise, please disconnect the motor in time within 3 seconds to avoid burning the motor sensor coil).
- 11、 Phase line, Hall line, the corresponding function color pair is connected to the interface on the corresponding driver, if the motor is stuck or abnormal rotation after the drive is powered on, the heat is relatively high, you can adjust the phase line, Hall line ordering, change the Angle of the electric machine a total of 36 kinds of connection, such as 36 kinds of adjustment or abnormal, you must contact the drive adjustment system

- 12、 before powering on, please ensure that the controller and the motor are connected correctly, and ensure that the power supply voltage is within the specified range. For your safety, please lift the hub motor off the ground when powering on for the first time, keep the motor suspended, and then power on the drive (select according to the matching motor, start the drive motor has a current card, please power off within 3 seconds

Brake system configuration

1. Electronic brake; D1 (unilateral exit shaft), S1 (bilateral exit shaft) configuration standard, is attracted to each other through the magnetic field, generated a resistance called electronic brake

2. Disc brake; D2 (unilateral exit shaft), S2 (bilateral exit shaft) configuration standard, is through one end cap

There is a fixed disc brake, and the brake is realized by adding resistance to the disc brake through the mechanical structure

3. Hub brake; D3 (single exit axle), S3 (double exit axle) configuration standard, is through one end cap hub A hub brake disc is formed, and the brake disc is subjected to resistance by mechanical structure.

common parameter

Motor maximum RPM: According to the highest speed of the motor and the highest speed required by the user. Given speed

Do not exceed the maximum motor speed.

Maximum motor current: This refers to the maximum current of the motor, which generally corresponds to the maximum peak value of the motor

The current cannot exceed the maximum current specified by the motor type.

Motor movement direction: motor movement forward and backward direction switching is completely synchronous without difference.

Sensor class: 霍尔 (HALL)

<https://electricassistcart.com>

installation notice

1. Connect the motor to the controller and power supply according to the wiring diagram on the controller.

2. The motor installs tires outside the outer rotor hub.

3. The power cord passes through the metal parts and is protected by non-metal products.

4. Do not turn when turning: the power cord is not firmly installed - rewire;

5. Motor normal noise: Hall component is bad - replace.

6. Pay special attention to when the motor is powered on, the motor is not moving or stuck, and the abnormal heat is relatively fast

Within three seconds must be disconnected and adjusted electrical Angle or drive output to avoid motor failure

7. Contact the after-sales service for more questions

It is forbidden for third parties to reprint, copy, steal or sell documents without permission

The document is for reference only. If there is any editing error, the company will not bear any responsibility

The documents are internal information, and the company does not bear any legal responsibility if the use infringes the rights of others